

Corredera elevadora serie 970
Marcos

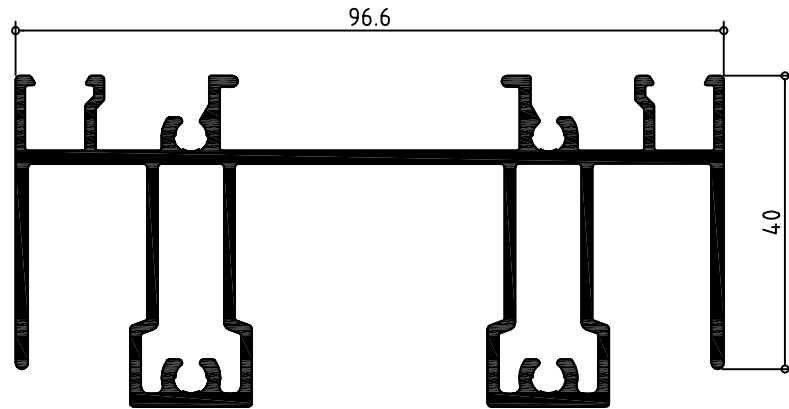

970225

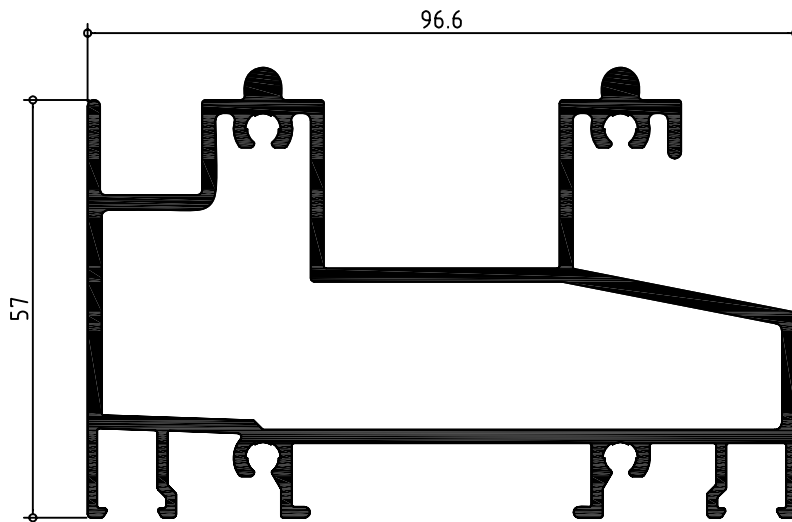

970186

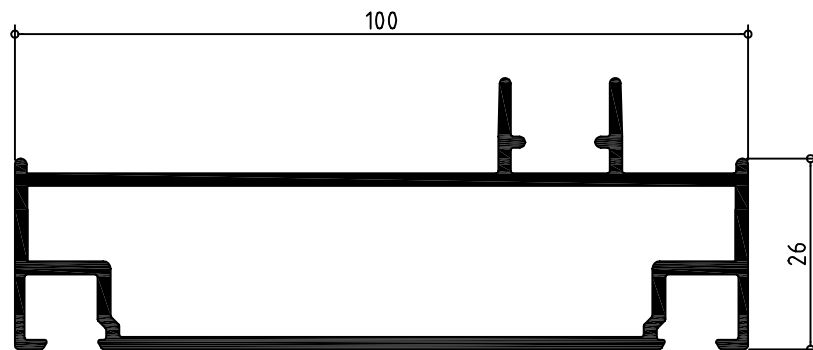

970530

Corredera elevadora serie 970

Hojas

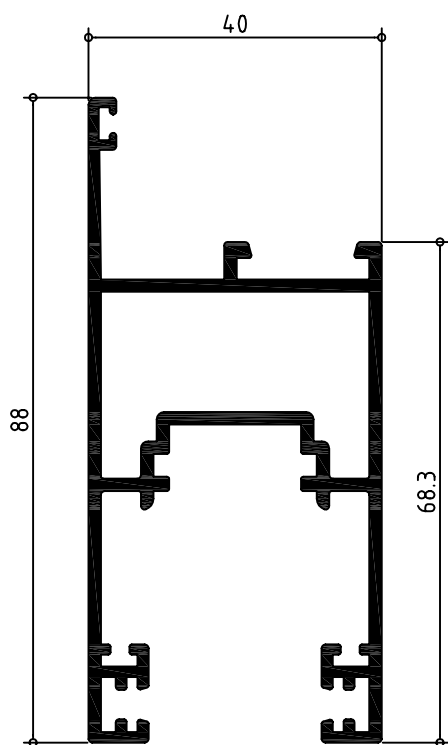

970340

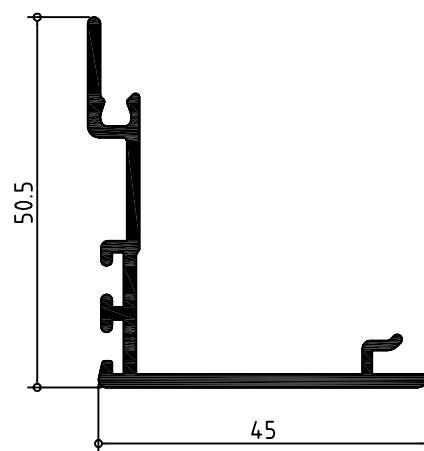

970255

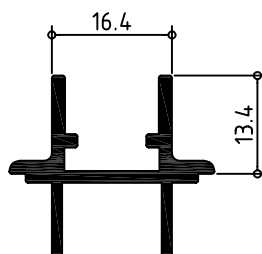

970761

Corredera serie 970 ELEVADORA

Secciones y hoja de corte



Puerta de dos hojas correderas

PERFIL	CODIGO	POSICION	UNIDADES	CORTE	MEDIDA
	970225	Horizontal	1		H - 51 mm.
	970186	Horizontal	1		H - 51 mm.
	970530	Vertical	2		= A
	970340	Vertical	4		A - 81 mm.
		Horizontal	4		(H+32):2
	970255	Vertical	2		A - 81 mm.

Accesorios

DESCRIPCION	UNIDADES 2 HOJAS
Kit 2 hojas	1
Escuadra hoja	-
Cierres	2
Defectores salida agua	2
Roldanas	4
Escuadras de alineamiento	16
Patín guíador 4 hojas	-
Cepillo 7x7	6H+4L

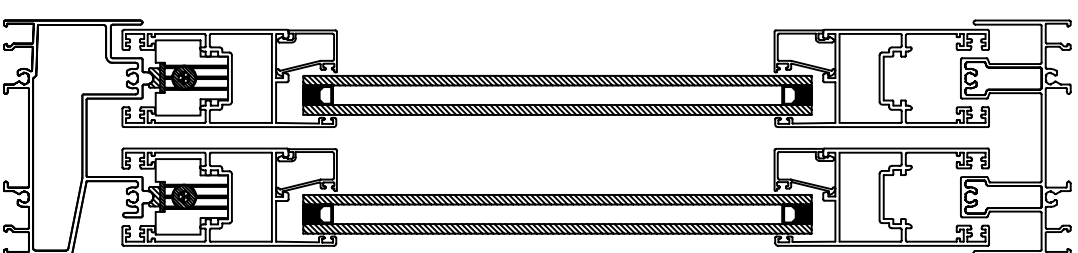
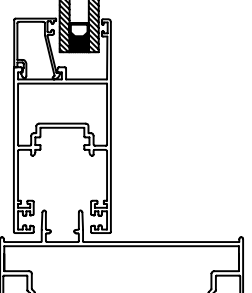
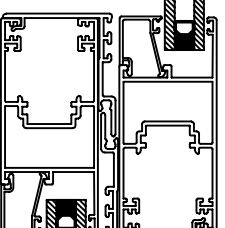
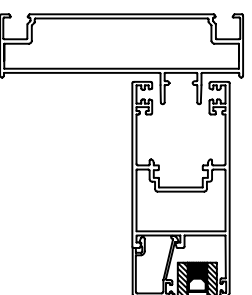

Corredera serie 970 ELEVADORA

Secciones y hoja de corte



Puerta de dos hojas correderas

PERFIL	CODIGO	POSICION	UNIDADES	CORTE	MEDIDA
	970225	Horizontal	1		H - 51 mm.
	970186	Horizontal	1		H - 51 mm.
	970530	Vertical	2		= A
	970340	Vertical	8		A - 81 mm.
		Horizontal	8		(H+113)/4
	970255	Vertical	4		A - 81 mm.
	970761	Vertical	1		A - 81 mm.

Accesorios

DESCRIPCION	UNIDADES 2 HOJAS
Kit 4 hojas	1
Escuadra hoja	-
Cierres	3
Defectores salida agua	2
Roldanas	8
Escuadras de alineamiento	16
Patín guíador 4 hojas	-
Cepillo 7x7	6H+4L

